

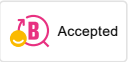

Unique characteristics

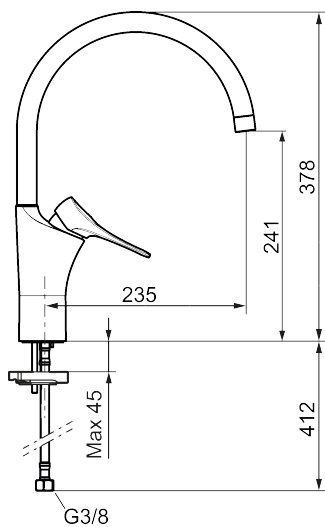

Backflow protection unit type **AA**



9000XE kitchen mixer

Article number: 86027010 **Flow 3 bar:** 4.5 l/m

Description: Chrome, with integrated electronic dish washer cut-off, LEED/BREEAM compliant

- Cold Start
- Ceramic cartridge with soft closing function
- Adjustable flow control and temperature limiter
- Eco Flow (energy and water saving aerator)
- Swivel spout, limitation part for 60°, 85°, 110° or 360° included
- With integrated electronic dish washer cut-off, automatic shut-off after 4 or 12 hours
- Soft PEX® hoses with 3/8" connecting nut (stainless steel braided)
- Lead Free material
- Hole diameter Ø34-37 mm