



9000E hospital mixer (Antibactus)

Article number: 82627800

Description: Chrome, TMV3

- Pressure balanced thermostatic mixer
- With ceramic sealed headwork
- Equipped with system for thermal disinfection against legionella
- On/off headwork with long lever on top
- Temperature handle with safety stop at 38°C
- Approved non-return valves, EN-Standard EN1717
- Spout must be ordered separately

Uniqe characteristics

Backflow protection unit type



PRODUCT DESCRIPTION

9000E hospital mixer (Antibactus)

Article number: 82627800

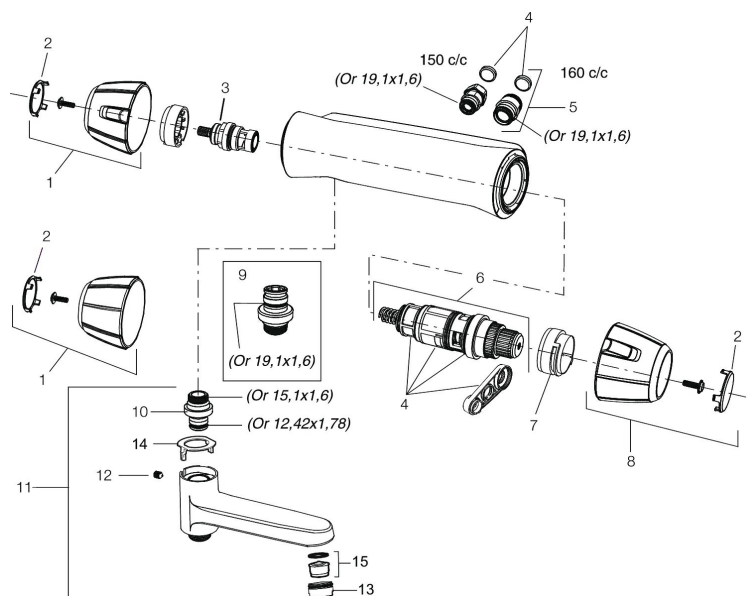

Sparepartlist

NO.	FMM NO.	RSK	DESCRIPTION
1	35781000	8592015	On/off handle, complete, chrome
1	35780040	8591995	On/off handle, complete, black
2	39031004	8592004	Cover, black, 2 pcs
3	35900800	8585849	Ceramic on/off headwork
4	38680009	8591701	Filter kit incl. o-rings and service tool
5	59810800	8592006	Inlet connectors 150 c/c (left-handed thread)
5	59800800	8592005	Inlet connectors, 160 c/c
6	38601009	8591609	Thermostatic cartridge, complete, incl. service tool
7	38520007	8591592	Scalding protection ring, standard (black)
7	38520005		Scalding protection ring, max 38 °C, black
8	35780100	8591998	Temperature handle, complete, chrome
8	35780140	8591997	Temperature handle, complete, black
9	39710800	8591967	Nipple M18x1-G1/2 for shower mixer
10	39754000	8591969	Nipple M18x1 with o-ring for bath mixer
11	82990000	8154073	Swivel spout with integrated diverter
12	38086000	8439701	Locking screw
13	29142400	8281526	Housing M24 ext., 13 mm

NO.	FMM NO.	RSK	DESCRIPTION
14	38521000	8295345	Stop ring
15	29102650	8281547	Aerator insert, 20–24 l/min at 300 kPa