



9000XE kitchen mixer

9000XE kitchen mixer with C-spout in chrome suits any kitchen, whatever its size. This kitchen mixer is lead-free and equipped with our smart, innovative, energy-saving functions such as cold start, soft closing, a temperature limiter function and an energy- and water-saving aerator. Its timeless, practical design makes it a functional and aesthetically durable addition to any modern home. This product is LEED certified, which means it meets the flow rate requirements applicable to certain new buildings and conversions.

Article number: 86007010 **Flow 3 bar:** 4.5 l/m

Description: Chrome, 4,5 l/min, LEED compliant

Unique characteristics

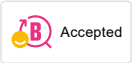

Backflow protection unit type

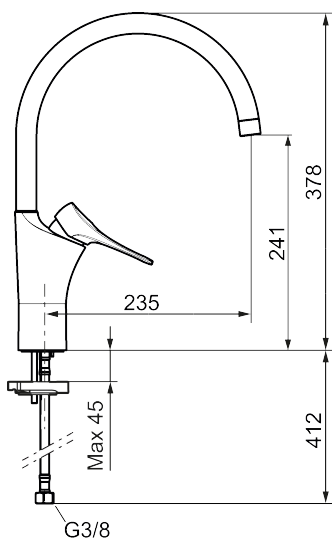

- Cold Start
- Ceramic cartridge with soft closing function
- Adjustable flow control and temperature limiter
- Eco Flow (energy and water saving aerator)
- Swivel spout, limitation part for 60°, 85°, 110° or 360° included
- Soft PEX® hoses with 3/8" connecting nut (stainless steel braided)
- Lead Free material
- Hole diameter Ø34-37 mm