



## 9000XE kitchen mixer

9000XE kitchen mixer with C-spout in brushed chrome suits any kitchen, whatever its size. This kitchen mixer is lead-free and equipped with our smart, innovative, energy-saving functions such as cold start, soft closing, a temperature limiter function and an energy- and water-saving aerator. Its timeless, practical design makes it a functional and aesthetically durable addition to any modern home. This product is LEED/BREEAM compliant, which means it meets the flow rate requirements applicable to certain new buildings and conversions.

**Article number:** 86007413 **Flow 3 bar:** 3.1 l/m

**Description:** Brushed chrome, LEED/BREEAM compliant

### Unique characteristics

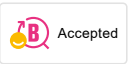

Backflow protection unit type 

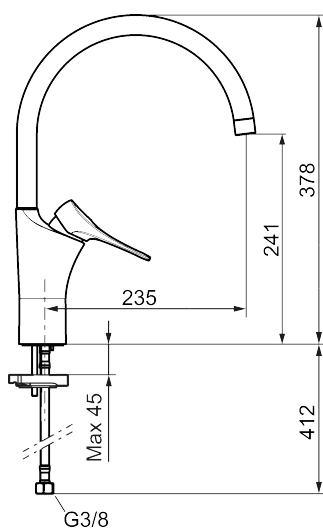

- Cold Start
- Ceramic cartridge with soft closing function
- Adjustable flow control and temperature limiter
- Eco Flow (energy and water saving aerator)
- Swivel spout, limitation part for 60°, 85°, 110° or 360° included
- Soft PEX<sup>®</sup> hoses with 3/8" connecting nut (stainless steel braided)
- Lead Free material
- Hole diameter Ø34-37 mm