



9000XE bath mixer

9000XE bath tub mixer is a mixer in chrome with carefully balanced pressure and temperature regulation, low weight, and noise absorbing as well as energy-saving functions. It is also equipped with double check valves for added safety.

Article number: 86901500 **Flow 3 bar:** 22.7 l/m

Description: Chrome, 150 c/c

Unique characteristics

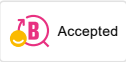

- Pressure balanced thermostatic mixer
- Swivel spout with built-in diverter
- With ceramic sealed headwork
- Temperature handle with safety stop at 38°C
- With Eco-function
- Lead Free material
- Approved non-return valves, EN-Standard EN1717

Backflow protection unit type **EB**

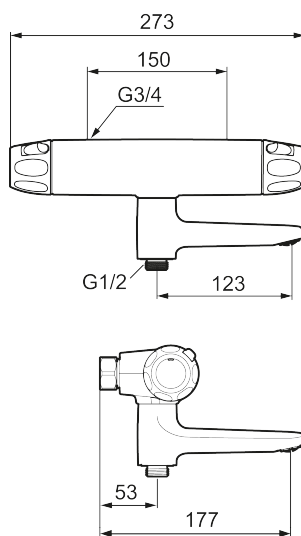

PRODUCT DESCRIPTION

9000XE bath mixer

9000XE bath tub mixer is a mixer in chrome with carefully balanced pressure and temperature regulation, low weight, and noise absorbing as well as energy-saving functions. It is also equipped with double check valves for added safety.

Article number: 86901500

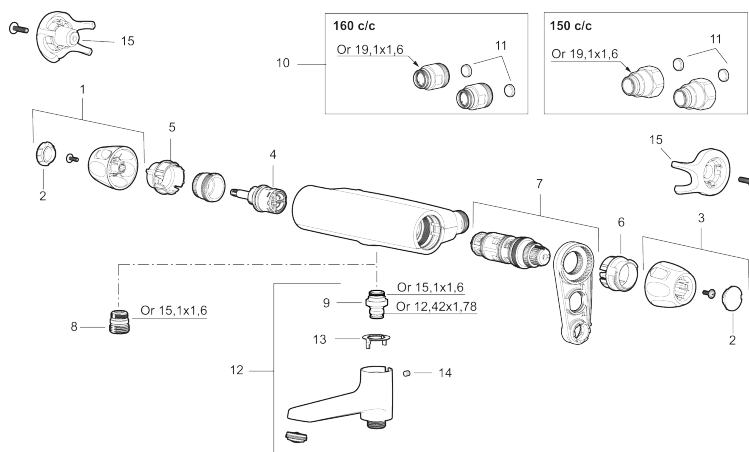

Sparepartlist

NO.	FMM NO.	RSK	DESCRIPTION
1	S600083	8218917	On/off handle, complete, krom
1	S600083.75	8218919	On/off handle, complete, brushed chrome
2	S600116	8218920	End cover, chrome
2	S600116.75	8218922	End cover, brushed chrome
3	S600082	8218914	Temperature handle, complete, chrome
3	S600082.75	8218916	Temperature handle, complete, brushed chrome
4	S600020	8441462	Ceramic headwork, with service tool (shower mixer)
4	S600269	8387232	Ceramic headwork, without tool (shower mixer)
4	S600021	8441463	Ceramic headwork, with service tool (bath mixer)
4	S600270	8387233	Ceramic headwork, without tool (bath mixer)
5	S600086	8439710	Stop ring, standard
6	S600087	8439711	Scalding protection ring
6	S600026	8439708	Scalding protection ring, max 42 °C
7	S600084	8439709	Thermostatic cartridge, complete, incl. service tool
7	S600271	8397030	Thermostatic cartridge, complete, without service tool
8	S600088	8439712	Nipple M18x1–G1/2 for shower mixer
9	39754000	8591969	Nipple M18x1 with o-ring for bath mixer
10	59800800	8592005	Inlet connectors, 160 c/c
11	38632006	8590311	Filter

NO.	FMM NO.	RSK	DESCRIPTION
12	S600077	8241000	Swivel spout with integrated diverter, chrome
12	S600077.75	8357750	Swivel spout with integrated diverter, brushed chrome
13	38521000	8295345	Stop ring
14	38086000	8439701	Locking screw
15	S600105	8439713	Care-handle, black, 2 pcs