

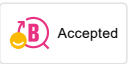

Unique characteristics

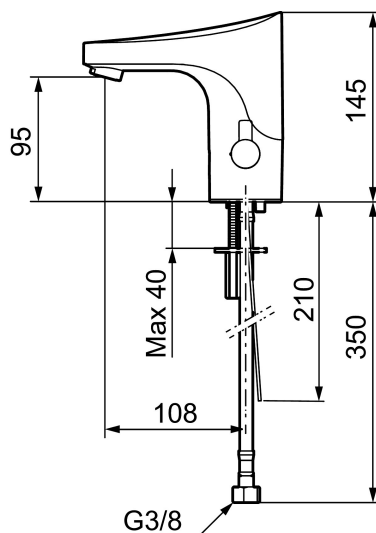

Backflow protection unit type **EB**



9000E tronic WMS basin mixer, battery operation

The touch-free 9000E Tronic basin mixer is LEED and BREEAM compliant, saves water and energy and is simple and hygienic to use. It is made from a lead-free material which, in combination with its energy efficiency, can earn LEED points in the Materials category of the LEED building rating system.

The water temperature is easy to adjust using a knob on the side of the mixer. The knob can be locked to prevent the water from overheating and causing scalding, or it can be removed if the tap is to be used in environments where a preset temperature is needed. The mixer also has a programmable hygiene flushing function which prevents stagnant water from accumulating, thus reducing risk of bacterial growth in the water pipes.

And to obtain even more advanced functionality, the mixer can be connected to our innovative digital cloud service, Tronic WMS. This allows the mixers to be monitored, analysed and evaluated, providing valuable information which can be used to improve operation and use.

About the collection

Our touch-free mixer taps are developed in Sweden and have a water- and energy-saving design. What's more, they help improve daily hygiene and safety because the tap can be used without touching the mixer. All the technology is integrated inside the mixer body, making the mixer as easy to install as a traditional basin mixer.

Article number: 16416033

Description: Brushed chrome, battery operation (included battery), LEED/BREEAM compliant

- WMS-mixers with possibilities of wireless connection (subscription is required)
- Adjustable hygiene flushing, intervals and rinsing time (to avoid stagnant water)
- Logging of all flushings with point of time, water consumption and temperature for individual mixer or group of mixers (minimum, maximum and average values)
- Battery monitoring

- Built-in temperature measurements of mixed water temperature
- Programmable temperature stop, the mixer will turn off directly at set maximum temperature
- Soft closing solenoid valve
- Safe against vandalism, complete in metal
- Eco (energy and water saving constant flow aerator)
- Flush Timeout - safety shut-off to prevent flooding
- Rinse time
- Time limited shut-off (eg for cleaning)
- Low power consumption - Long life
- Equipped with system for thermal disinfection against legionella
- Battery operation, can be converted to mains operation
- IP class sensor, IP67
- Approved non-return valves, EN-Standard EN1717
- Environmental friendly material, Lead free, Nickel Free

Installation:

- Note! Gateway and a subscription is required for WMS
- Automatic sensor calibration
- After adjusting to the desired temperature, knob can be replaced with a lid
- Easy to change battery, without turning off the water supply
- For mains operation requires installation of the adapter kit FMM S600147
- Soft PEX[®] hoses with integrated non return valves and filters (stainless steel braided)
- Hole diameter Ø33,5-37 mm

Settings:

- Adjustable max temperature
- With Gateway and WMS:
 - Hygiene flushing with adjustable time and intervals
 - Initiate hot water rinsing
 - Programming of rinsing times, temperature alarm och temperature stops
 - Alert signal if exceeding the time limit for stagnant water (the latest flushing)