



9000XE kitchen mixer

9000XE kitchen mixer with C-spout in brushed chrome suits any kitchen, whatever its size. This kitchen mixer is lead-free and equipped with our smart, innovative, energy-saving functions such as cold start, soft closing, a temperature limiter function and an energy- and water-saving aerator. Its timeless, practical design makes it a functional and aesthetically durable addition to any modern home. This product is LEED certified, which means it meets the flow rate requirements applicable to certain new buildings and conversions.

Article number: 86007413 **Flow 3 bar:** 3.1 l/m

Description: Brushed chrome, 3,1 l/min, LEED compliant

Unique characteristics

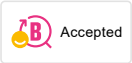

Backflow protection unit type

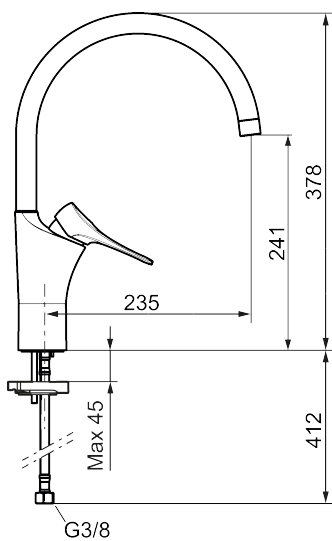

- Cold Start
- Ceramic cartridge with soft closing function
- Adjustable flow control and temperature limiter
- Eco Flow (energy and water saving aerator)
- Swivel spout, limitation part for 60°, 85°, 110° or 360° included
- Soft PEX® hoses with 3/8" connecting nut (stainless steel braided)
- Lead Free material
- Hole diameter Ø34-37 mm

PRODUCT DESCRIPTION

9000XE kitchen mixer

9000XE kitchen mixer with C-spout in brushed chrome suits any kitchen, whatever its size. This kitchen mixer is lead-free and equipped with our smart, innovative, energy-saving functions such as cold start, soft closing, a temperature limiter function and an energy- and water-saving aerator. Its timeless, practical design makes it a functional and aesthetically durable addition to any modern home. This product is LEED certified, which means it meets the flow rate requirements applicable to certain new buildings and conversions.

Article number: 86007413

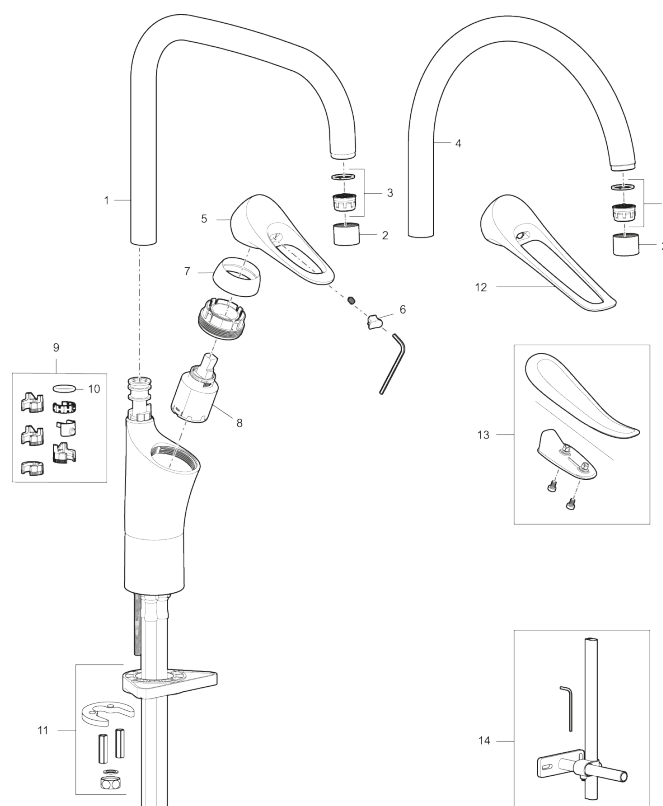

Sparepartlist

NO.	FMM NO.	RSK	DESCRIPTION
1	S600103	8387035	Spout, U-model, chrome
1	S600103.75	8387037	Spout, U-model, brushed chrome
2	S600155	8280012	Housing M22 int., chrome
2	S600155.75	8280013	Housing M22 int., brushed chrome
3	29102910	8281534	Aerator insert, 5,5–6,5 l/min at 300kPa
3	29100500	8281532	Aerator insert, 5 l/min at 200–600 kPa
3	S600072	8281671	Aerator insert, 3 l/min at 200–600 kPa

NO.	FMM NO.	RSK	DESCRIPTION
4	S600102	8387032	Spout, C-model, chrome
4	S600102.75	8387034	Spout, C-model, brushed chrome
5	S600096	8387022	Lever, complete, chrome
5	S600096.75	8387024	Lever, complete, Brushed chrome
6	S600097	8387025	Cover lid with colour marking
7	S600101	8387029	Cover sleeve, chrome
7	S600101.75	8387031	Cover sleeve, brushed chrome
8	S600098	8387026	Ceramic cartridge with tool, for kitchen mixers
8	S600209	8387039	Ceramic cartridge, for kitchen mixers
8	S600100	8387028	Ceramic cartridge with tool, for kitchen mixer (LEED) and basin mixer
8	S600099	8387027	Ceramic cartridge, for kitchen mixer (LEED) and basin mixer
9	58641000	8594560	Lock kit for swivel spout
10	37801550	8295350	O-ring 15,54 x 2,62, 2 pcs
11	39142800	8186893	Fastening kit, for kitchen mixer with on/off valve
12	S600175	8387083	Care-lever, complete
13	S600106	8397001	Care-kit
14	39147000	8592050	Stabilizer kit