

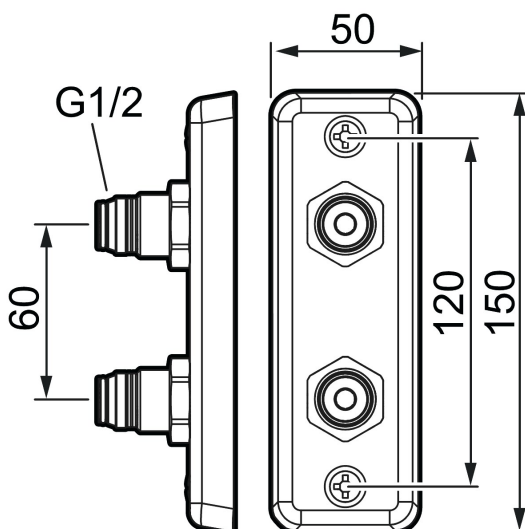

Unique characteristics



Double wall bracket for PE-X-, PE-RT-, PB- and multilayer-pipes

Article number: S600047

Description: Chrome, D: Ø15

- Swivel nipples with radial adjustment
- With wall seal
- Wall channel for the connection between concealed and visible piping, the pipe joint is placed outside the wall

Connections has product certification issued by a product certification body in Sweden, RISE Certification, for:

- PE-X enligt EN ISO 15875: 15x2.5, 16x2.0 & 16x2.2
- PE-RT enligt EN ISO 22391: 15x2.5 & 16x2.2
- PB enligt EN ISO 15876: 16x2.0

Multilayer pipe by manufacture:

- Uponor UNI PIPE PE-RT/AL/PE-RT 16*2
- Geberit 16*2,0 Systemrohr ML Flowfit/pushfit PE-RT typ II
- Thermotech MultiSystem AluComposite PE-RT Type2/AL/PE-RT Typ2 16*2
- Roth Systemrohr Alu-Laserplus 16*2 mm PE-RT TypII/Al/PE-RT TypII
- LK PAL Universal Pipe A16 16*2,0
- TECElogo dimension 16 – multilayer pipe – PE-RT/Al/PE-RT 16*2,0 mm
- TECElogo dimension 16 – multilayer pipe – PE-Xc/Al/PE-RT 16*2,0 mm
- FRÄNKISCHE turatec multi 16*2 PE-RT II/Al/PE-RT II
- HENCO RIXc PE-Xc/Al/PE-Xc 16*2
- Purmo MultiSystem PE-RT /Al/PE-RT – Typ II 16x2,0