



## Garden valve with vacuum valve and plastic handle

Our garden valves are self-draining and therefore frost-proof even if you forget to dismantle the garden hose before the season with degrees below zero. However, we recommended that you always remove the hose and coupling when there is a risk of low temperatures.

Article number: 42940610

Description: For wall thickness max. 600 mm

### Unique characteristics

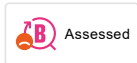

Backflow protection unit type

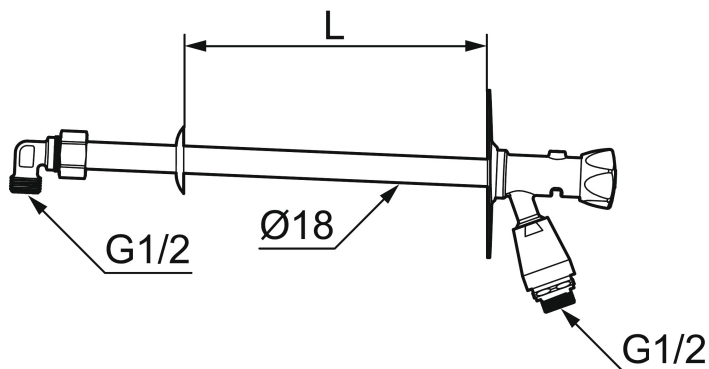

- Self-draining
- With vacuum valve and plastic handle
- With approved non-return valve
- Frost-proof even if the hose/coupling is connected
- Can be cut to suit wall thickness
- Wall bracket: H=106 mm, W=66 mm, diagonal screw holes
- Approved backflow prevention device, EN-Standard EN 1717

## PRODUCT DESCRIPTION

### Garden valve with vacuum valve and plastic handle

Our garden valves are self-draining and therefore frost-proof even if you forget to dismantle the garden hose before the season with degrees below zero. However, we recommended that you always remove the hose and coupling when there is a risk of low temperatures.

Article number: 42940610

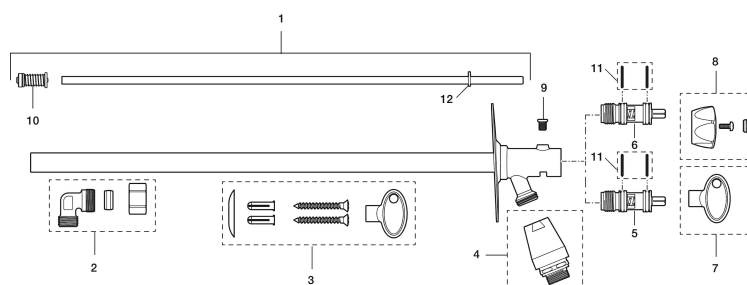

### Sparepartlist

NO.	FMM NO.	RSK	DESCRIPTION
1	37570400	4316710	Spindle, L=400 mm
1	37570600	4316711	Spindle, L=600 mm
1	37571000	4316712	Spindle, L=1000 mm
2	37551000	4316708	Valve body with cone and nut
3	39144300	4316713	Fastening details
4	29815000	5045393	Chrome, 10 pcs
4	29815009	5045391	Chrome
5	35160009	4316706	Headwork for loose key, retail packed
6	35160019	4316707	Headwork for loose handle, retail packed
7	42760009	4316714	Key, retail packed
8	42770000	4316715	Handle
9	37590000		Screw M5x6
10	37580000	5438346	Valve cone kit for spindle 3757
11	37801790	8314140	O-ring 17,3 x 2,4, 2 pcs
12	37521000		Guiding ring, 3 pcs