



9000XE basin mixer

9000XE basin mixer LEED/BREEAM compliant is a basin mixer in chrome. Its classic design and water-saving function make it a natural choice for the bathroom. This product is LEED/BREEAM compliant, which means it meets the flow rate requirements applicable to certain new buildings and conversions.

Article number: 86507310 **Flow 3 bar:** 3.0 l/m

Description: Chrome, LEED/BREEAM compliant

Unique characteristics



Backflow protection unit type

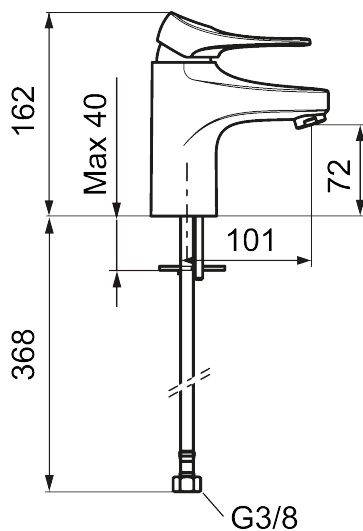

- Cold Start
- Ceramic cartridge with soft closing function
- Adjustable flow control and temperature limiter
- Eco Flow (energy and water saving aerator)
- Soft PEX[®] hoses with 3/8" connecting nut (stainless steel braided)
- Lead Free material
- Hole diameter Ø34-37 mm